



PES Filter Cartridge

Designer-Manufacturer-Exporter-Supplier





PES Filter Cartridge

PES Cartridges are made of poly ether Sulphone with uniform pore distribution to ensure maximum performance in bacterial retentions. It's upstream & down stream polyester support ensures resistance to pressure shocks. Polyethersulphone membrane is hydrophilic in nature, it allows easy integrity testing for all applications where daily controls are required. The membrane possesses broad chemical compatibilities & contains no surfactants. PES Cartridges are produced in controlled environments & under stringent production conditions that ensure filter quality & cleanliness. These are assembled integrally by thermowelding. This process minimizes the presence of oxidization of substance & yield a durable filter cartridges suitable for extended use. This can be sanitized by chemical agents or by inline steaming. PES and polypropylene, the unique two materials used in cartridge manufacturing are chemically inert, not shedding and biologically safe according to F.D.A., USP and EEC requirements for pharmaceutical and food contact use. The filtration area of each cartridge is as high as 0.7 m². Therefore it offers high flow rate, low pressure drop & long service life.

Features & Benefits

- PES Membrane is inherently hydrophilic with excellent hydrolytic stability & chemical compatibility
- Specific pore size distribution for full bacterial retention to ensure sterile effluent even under process upsets
- End caps and connectors are sealed by thermal bond, free from binder.
- Low pressure drop and high flow rate due to high filtration area of 0.7 m² Per 10" cartridge
- Absolute rated
- Autoclave or in situ steam sterilization features
- Integrity test is possible
- FDA approved

Technical Specifications

Sizes	: 10", 20", 30" 40" Long
Micron Rating	: 0.05, 0.1, 0.2, 0.45, 1 Micron
Filtration Area	: More Than 0.7 m ² Per 10" cartridge
Outer Diameter	: 69 mm
Inner Diameter	: 28 mm

Configuration

- Double Open Type (DOE Type)
- Code 7S (226 O' Ring Design / Bayonet)
- Code 7F (226 O' Ring Design / Flat)
- Code 3S (222 O' Ring Design / Bayonet)
- Code 3F (222 O' Ring Design / Flat)

Construction

- | | |
|--------------------|-------------------------------------|
| • Filter Media | : PES (Poly Ethersulphone) Membrane |
| • Support Media | : Polypropylene fiber |
| • Inner Core | : High strength polypropylene |
| • Outer Core | : High strength polypropylene |
| • End Caps | : High strength polypropylene |
| • O Ring / Gaskets | : EPDM / Buna N / Silicone / Viton |

Applications

- Pharmaceuticals
- Food & Beverages
- DI water Filtration

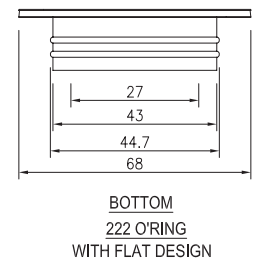
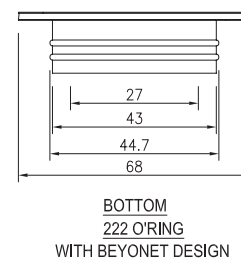
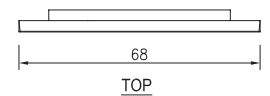
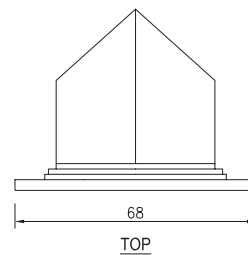
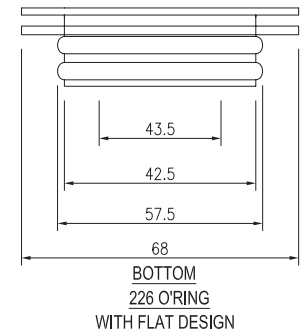
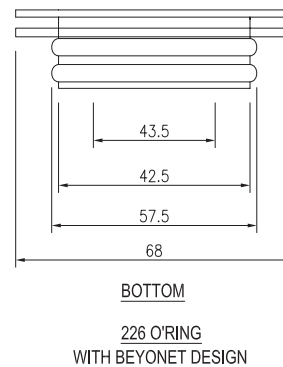
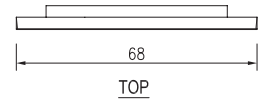
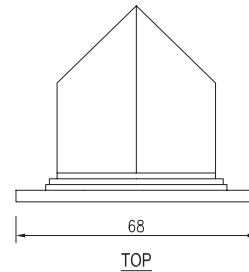



Designed By: e-brandstudio.com

Filter Concept Pvt. Ltd.

(An ISO 9001:2008, ISO 14001:2004, OHSAS 18001:2007 Certified Company)

Corporate Office

302, "Aalin", Opp.Gujarat Vidhyapith,
B/h. Jet Airways Office, Ashram Road, Ahmedabad - 14.
Gujarat, INDIA.

Phone : +91-79-2754 1602, 2754 0069, 3291 8518

Fax : +91-79-2754 0801

E-mail : info@filter-concept.com

Manufacturing Unit

A-6, Pushparaj Industrial Estate,
Nutan Mill Compound, B/h. City-Gold Theatre, Saraspur,
Ahmedabad-380018. Gujarat, INDIA.

Phone : +91-79-2220 1921, 2220 1292

Fax : +91-79-2220 1911

E-mail : factory@filter-concept.com